

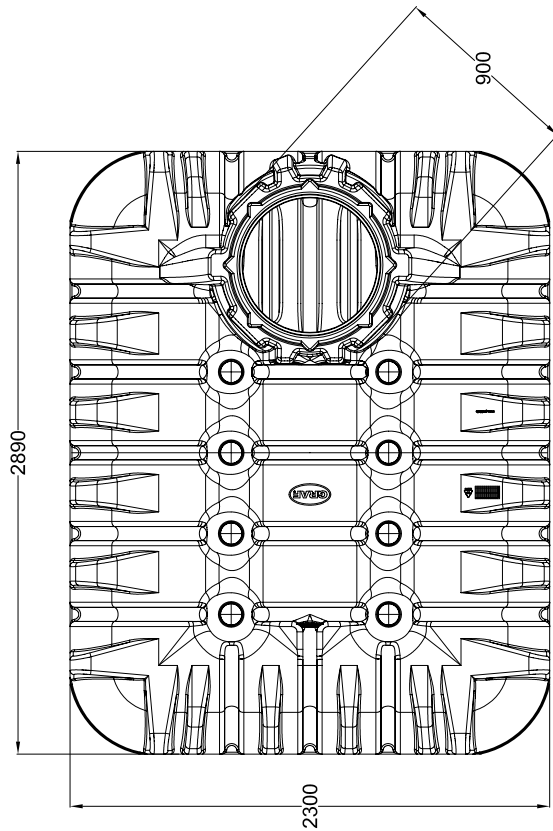

GRAF Rainwater Flat tank
Platin 5000 L

Order no.

390002

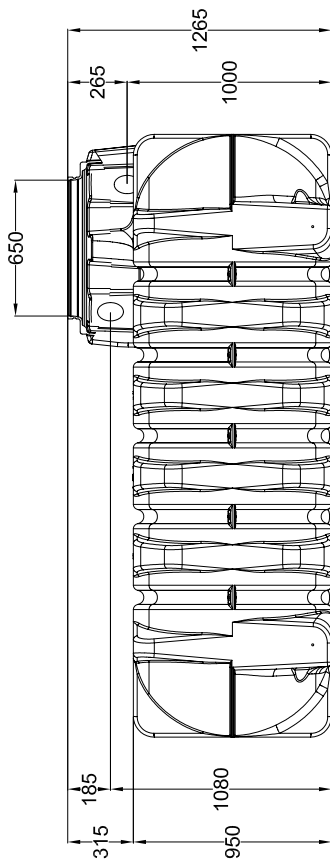
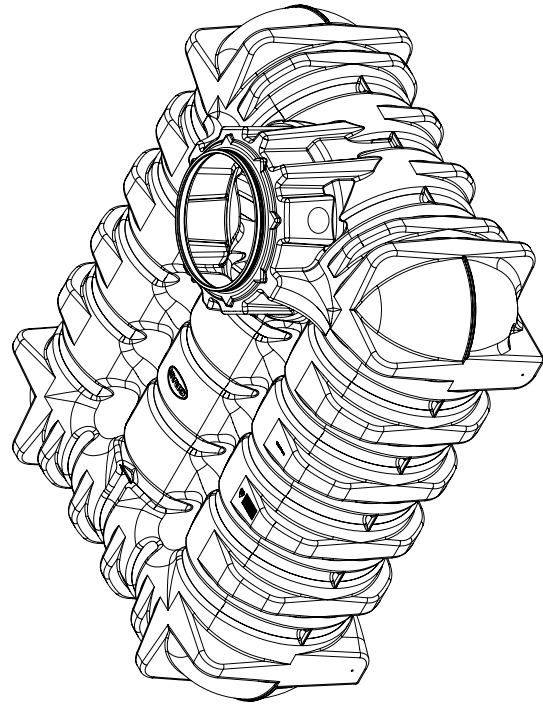
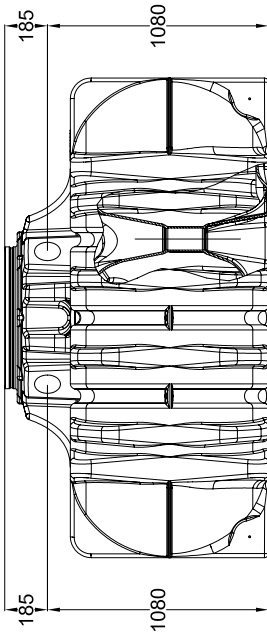

www.graf.info
info@graf.info

All Dimensions in mm
+/- 3 % Tolerance

Weight

Approx. 250 kg

Date

23.06.2010

Name

Sheet 1/1